



Quick Sheet Instructions

(506640, 507640, 509640, 512640)

40 Degree Pneumatic Fill Kits and Pneumatic Fill Lid (500790)

U:\MANUALS\990000\990003
JDS REV (2) 3-19-2010

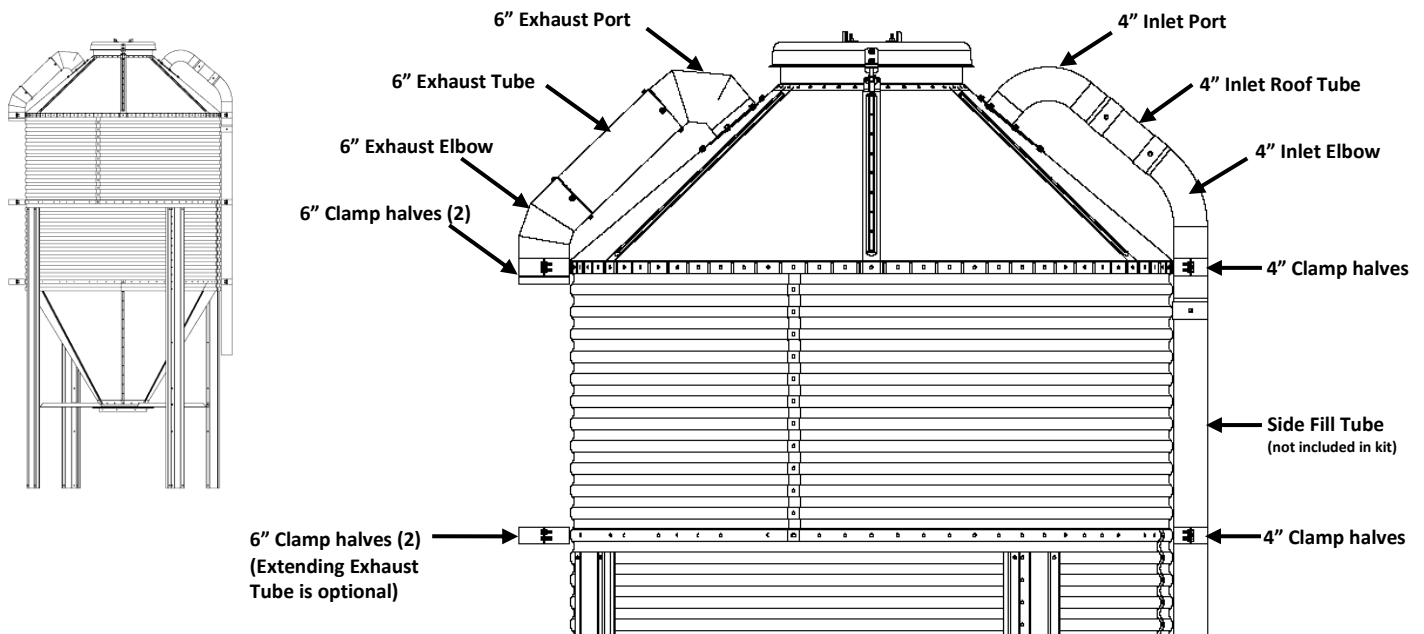

Inlet Assembly:

1. Connect the flared end of the 4" Inlet Port to one end of the 4" Inlet Roof Tube and the other end of the 4" Inlet Roof Tube to the flared end of the 40° Inlet Elbow piece using the 1/4" x 3/4" self-drilling screws in all pre-drilled holes on the flanged ends.
2. Attach the 4" narrow (half) clamp section to the roof at the seam to the bin with a carriage bolt and flange nut. (We recommend you do this before you attach the tube assembly to the roof section or insert the Side Fill tube for easier install.)
3. Apply a strip of caulking on both sides of the line of bolts between the plate and roof section. Now attach the plate at the end of the 4" Inlet Port to the roof section with the 5/16" x 1" Hex bin bolts w/washers and 5/16" Flange nuts. (Match pre-drilled holes on the plate to the pre-drilled holes on the roof section. Be sure not to spin the bolt which could damage the washer. We recommend that you tighten from the nut side.)
4. Connect the Side Fill Tube into the flanged end of the 40° Inlet Elbow piece and use the 1/4" x 3/4" self-drilling screws. (You may choose to attach to 40° Elbow before you attach the system to the roof if you prefer.)

5. Now attach the other 4" clamp to the clamp attached at the bin roof edge, with 5/16" Hex bin bolts w/washers and 5/16" Flange nuts, and a second clamp to the vertical wall (as pictured below).

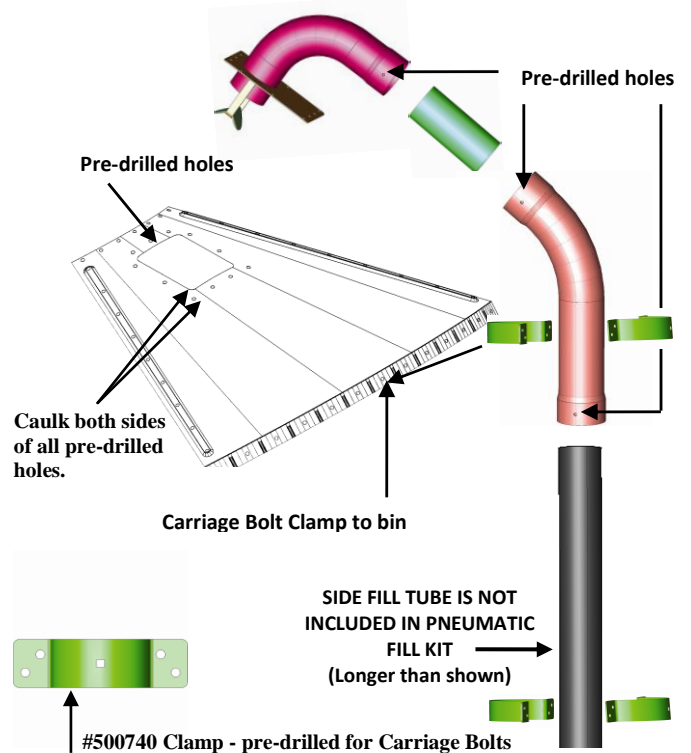

40 DEGREE PNEUMATIC FILL LID (500790)

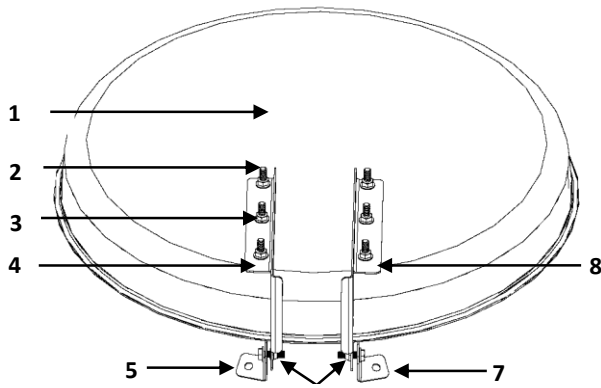

500790 PNEUMATIC FILL LID PARTS LIST

KEY	PART#	DESCRIPTION	QTY
1	500686	Lid	1
1	500780	Pipe Insulation	1
4	500948	Left Lid Hinge Bracket	1
5	500944	Left Hinge Bracket	1
7	500945	Right Hinge Bracket	1
8	500947	Right Lid Hinge Bracket	1
-	500780	½"ID x3/8 Wall x 6' Foam Insulation	1
-	500941	PF Lid Catch	1
-	500659	Lid Locking Bracket	1
-	500660	Lid Unlocking Arm	1
-	500662	Lid Lock Spring	1
HARDWARE			
2	501442	5/16-18 x 1 Hex Head Bin Bolt	8
3	501441	5/16-18 Flange Nut	6
6	012789	5/16-18 Nylock	7
9	010652	5/16 x 2-1/2-12 Hex bolt	3
-	010640	5/16-18 x ½ Hex Bolt	2

LID ASSEMBLY:

1. Attach the Left #500948 and Right #500947 Lid Hinge Brackets to the lid top, inserting the #501442 Hex Head Bin Bolts from the inside of the lid to the outside, as shown below, and secure with the #501441 Flange Nuts.

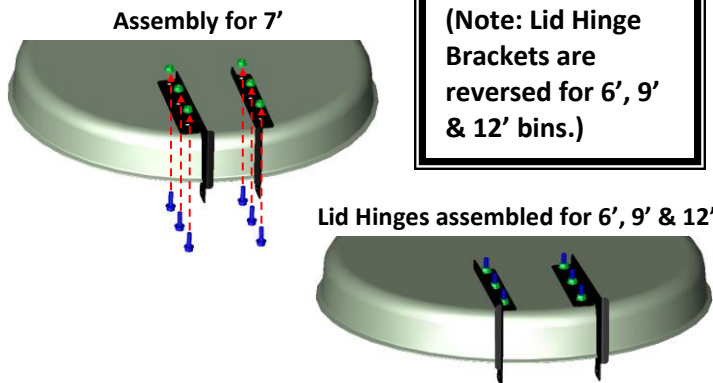

2. Attach #500780 Pipe Insulation by pushing the insulation at the slit onto the Lid Collar until it is snug as shown to below. (Adhesive is recommended)

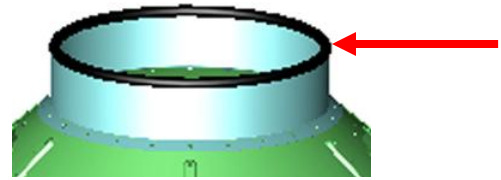

3. Attach the Left #500944 and Right #500945 Hinge Bracket to the Lid Hinge Brackets, (that are now attached to the lid), with the #501442 5/16-18 x 1 Hex Head Bin Bolts and #012789 5/16-18 Nylock Nuts as shown below.

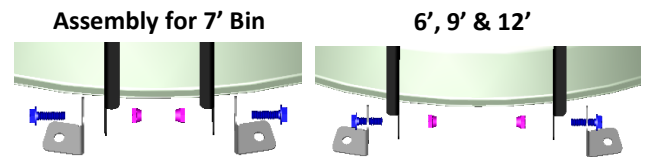

4. Now that you have the Lid Hinges attached to the lid you are ready to attach the Right and Left Hinge brackets to the Lid Collar with a #501442 5/16-18 Flange Bolt in each as shown below.

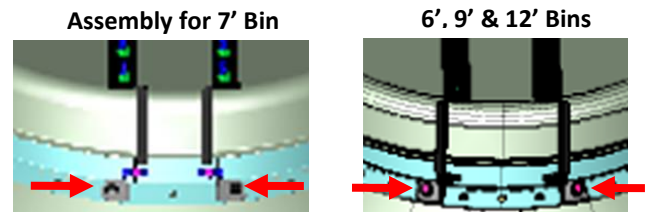

5. The Latch assembly; Locking Bracket, Unlocking Arm, and Spring are pre-assembled to the lid. Attach the #500941 PF Lid Catch including the #010652 5/16-18 Hex Bolt as shown below on bottom left, Using a #501442 5/16-18 x 1 Hex Head Bin Bolt, in the hole provided, to attach the Lid Catch to the Lid Collar edge, as shown below

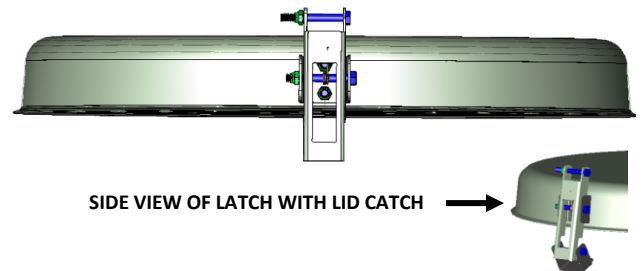

#500941 PF LID CATCH

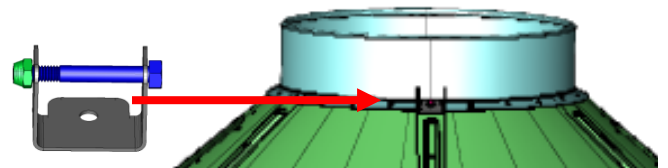

PNEUMATIC FILL KIT PART LISTS

Universal Pneumatic Fill Kit Components used by ALL KITS in addition to components listed in each kit below.

PART #	DESCRIPTION	QTY
500534	Caulking (50' roll)	1
500740	4" Narrow Clamp (half)	6
500743	6" Exhaust Port (elbow) w/plate	1
500744	6" x 24" galv. Duct elbow	1
500751	6" Exhaust clamp (half)	6
500786	4" inlet port w/plate	1
500788	51 Degree Elbow (drilled)	1
500942	Pneumatic Fill Hardware bag**	1
506640 - Pneumatic Fill Kit – Specific to 6' Bin Parts		
506425	6" x 16" Exhaust Tube	1
506918	4" x 8.8" Inlet (roof) Tube	1
*6' Side Fill Tubes - you should have ordered 1 of 3		
704411	4" x 7' Galv. Side Fill Tube (only)	1
704412	4" x 11' Galv. Side Fill Tube (only)	1
704413	4" x 15' Galv. Side Fill Tube (only)	1
507640 - Pneumatic Fill Kit – Specific to 7' Bin Parts		
507425	6" x 24" Exhaust Tube	1
507918	4" x 16.6" Inlet (roof) Tube	1
*7' Side Fill Tubes - you should have ordered 1 or 2 of 4		
704441	4" x 5' Galv. Side Fill Tube (only)	1
704412	4" x 11' Galv. Side Fill Tube (only)	1
704413	4" x 15' Galv. Side Fill Tube (only)	1
704414	4" x 19' Galv. Side Fill Tube (only)	1
704287	4" Tube Joiner (only 6 Ring Bin)	1
509640 - Pneumatic Fill Kit – Specific to 9' Bin Parts		
509425	6" x 39.87" Exhaust Tube	1
509918	4" x 32.82" Inlet (roof) Tube	1
*9' Side Fill Tubes - you should have ordered 1 or 2 of 4		
704441	4" x 5' Galv. Side Fill Tube (only)	1
704412	4" x 11' Galv. Side Fill Tube (only)	1
704413	4" x 15' Galv. Side Fill Tube (only)	1
704414	4" x 19' Galv. Side Fill Tube (only)	1
704287	4" Tube Joiner (only 6 Ring Bin)	1
512640 - Pneumatic Fill Kit – Specific to 12' Bin Parts		
512425	6" x 58.25" Exhaust Tube	1
512918	4" x 50.63" Inlet (roof) Tube	1
*12' Side Fill Tubes - you should have ordered 1 or 2 of 5		
704441	4" x 5' Galv. Side Fill Tube (only)	1
704411	4" x 7' Galv. Side Fill Tube (only)	1
704412	4" x 11' Galv. Side Fill Tube (only)	1
704413	4" x 15' Galv. Side Fill Tube (only)	1
704414	4" x 19' Galv. Side Fill Tube (only)	1
704287	4" Tube Joiner (only 5, 6, 7 Ring Bin)	1

Exhaust Assembly:

1. Connect 6" Exhaust Port to the Tube section then connect the Tube section to the (flexible) Exhaust Elbow (tube ends crimped for insertion). Then use the #14 Sheet Metal screws/Neoprene washers at pre-drilled holes of the tubes to secure. (as below)

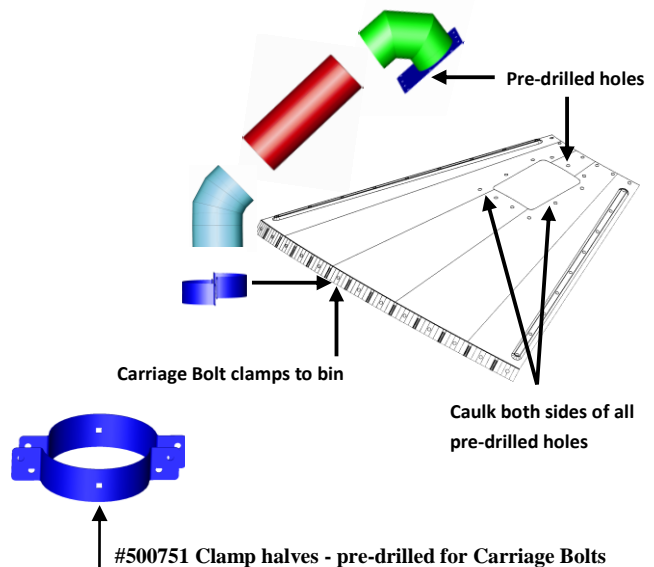

2. Attach one of the 6" Clamp halves to the roof at the seam to the bin with a carriage bolt/flange nut.
3. Apply caulking between the plate and roof section. Now attach the plate at the end of the Exhaust Port to the 6" roof section with the 5/16" x 1" Hex bin bolts w/washers and 5/16" Flange nuts. (Match pre-drilled holes on plate to the pre-drilled holes on the roof section.)
4. Attach and tighten the other half of the 6" Clamp around the bottom portion of the 6" Exhaust Elbow with 5/16" Hex bin bolts w/washers and 5/16" Flange nuts to secure. (6" Clamp halves (4) included for optional Exhaust extension tube.)

* Side Fill Tubes:

You should have ordered 1 of the appropriate choices out of the Side Fill Tube list and the Tube Joiner as needed.

**Hardware bag contains:

011453 (6) 5/16" x 1" Carriage bolts
 012425 (6) 1/4" x 3/4" Self drilling screws
 012494 (8) #14 x 5/8" Sheet Metal Screws
 500400 (8) 1/4" Neoprene Washers
 501441 (52) 5/16" Flange nuts
 501442 (46) 5/16" x 1" Hex bin bolts w/washer

North America:

Phone: 800.99VALCO
 (800.998.2526) Fax: 419.678.2200
 Email: sales@valcompanies.com



International:

Phone: 419.678.8731
 Fax: 419.678.2200
 Email: intl.sales@valcompanies.com